

PHC 06B-1X5MTR

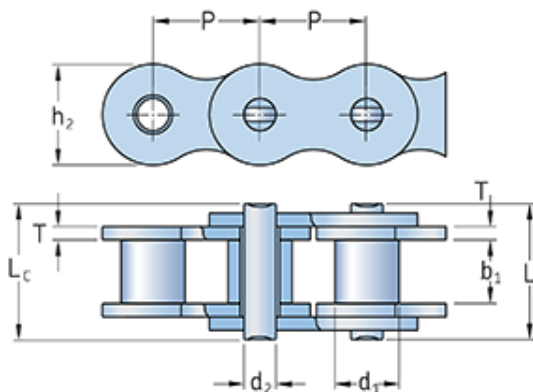

Pitch P (mm)	9.53
Roller diameter d1 max (mm)	6.35
Width between inner plates b1 min (mm)	5.72
Pin diameter d2 max (mm)	3.28
Plate height h2 max (mm)	8.2
Plate thickness T max (mm)	1.3
Weight (kg/m)	0.41